

Tie Technology DK, SK

Reliable sealing of tie points

Product Brochure – Issue 04/2019



Content

System advantages		Overview	
4	Tie Technology DK, SK	12	DK Sealing Cones
6	The right solution for all requirements	14	SK Anchor Cones
8	Careful working procedures guarantee tight and clean tie points		
10	Special application features		

Issue 04/2019

Publisher

PERI GmbH
Formwork Scaffolding Engineering
Rudolf-Diesel-Strasse 19
89264 Weissenhorn
Germany
info@peri.com
www.peri.com

Project examples

16 Tie Technology DK, SK

Components

18 Tie Technology DK, SK
components

Important information

All current safety regulations and guidelines applicable in those countries where our products are used must be observed.

The photos shown in this brochure feature construction sites in progress. For this reason, safety and anchor details in particular cannot always be considered as conclusive or final. These are subject to the risk assessment carried out by the contractor.

In addition, computer graphics are used which are to be understood as system representations. For ensuring a better understanding, these and the detailed illustrations shown have been partially

reduced to show certain aspects. The safety installations which have possibly not been shown in these detailed descriptions must nevertheless still be available. The systems or items shown might not be available in every country.

Safety instructions and load specifications are to be strictly observed at all times. Separate structural calculations are required for any deviations from the standard design data.

The information contained herein is subject to technical changes in the interests of progress. Errors and typographical mistakes reserved.



Tie Technology DK, SK

The difficulties

The conventional methods used to waterproof tie points are, in practice, not reliable. During hardening, shrinkage cracks form in the concrete which run through the entire wall thickness along the tie point. Difficulties also arise during striking. Construction sequences require striking to take place just one day after concreting. In the process, the tie rod nut is released by means of several hammer blows. Tie rods and mounting parts can therefore be shaken through the vibrations. Furthermore, the tension force of the tie rod acts in one direction after the release of one formwork half. This results in the formation of hairline cracks around the mounting parts. The customary expansion of the tie rod during concreting, and the inevitable compression when being released, results in cracks being formed between the tie rod and concrete.

The requirements

The two variants from PERI fully meet the requirements.

In order to seal the tie points, great care must be taken regardless of the method used.

PERI has developed a new technique for the subsequent sealing of tie points. Thereby, there is a much better chance of achieving dense and tight walls rather than using conventional solutions. By sealing the tie points, the end result can still be influenced whereas embedded sealing components are no longer accessible. And the experienced operator knows just how many uncertainties are involved in concreting and curing.

The solution

PERI Tie Systems DK and SK are:

- waterproof
- gas impermeable
- fire-resistant F 90
- soundproof

Faulty mounting of waterstop centre piece

One very common installation error is working with spacer tubes on the two tie rods on either side of the mounted component. These permeable tubes allow the water to penetrate right into the middle of the wall thus making the expensive waterstop centre piece ineffective.



Shrinkage crack formation endangers the water impermeability with waterstop centre pieces ...

Faulty mounting of fibre concrete spacer tube

The biggest disadvantage is that the tubes can split. One hammer blow too many or slight overtightening of the nuts leads to cracking or splitting of the fibre concrete spacer tubes.



... as well as with concreted tie rods.

The safe solution

With PERI Tie Technology DK and SK.



A tightly closed tie point is the most cost-effective!

The right solution for all requirements

DK Sealing Cone System

Advantages

- DK Sealing Cones can be effortlessly unscrewed with the cone spanner.
- DK Sealing Cones can be re-used many times.
- All DK Sealing Cones DW 15, 20, 26 have the same outside form, i.e. one concrete cone fits all cone openings.
- Targeted use for dealing with seepage water.
- Waterproof concrete, soundproof and fireproof walls for wall thicknesses up to 60 cm.

Application

The system consists of 2 re-usable DK Sealing Cones and one concreted Spacer Tube. The end-to-end tie rod is advantageous when shuttering. The Sealing Ring DW 15 between the cone and formwork compensates for any unevenness, and prevents laitance trickling in.



SK Tie Cone System

Advantages

- SK Tie Cones have a long service life. Plastic tubes can be replaced.
- SK Tie Cones can be simply unscrewed for ease of striking.
- Used for walls in high security areas with lost tie rods.
- Can also be used as a stable spacer with tube for wall thicknesses greater than 60 cm. The tie rod is re-usable.

Application

The SK System consists of 2 re-usable SK Tie Cones and 3 tie rods, the middle one of which can be embedded in the concrete (e.g. for vaults and strong-rooms, and buildings providing radiation protection). For all other applications, a spacer tube is used to enable the middle tie rod to be recovered. The closing process with the Sealing Ring DW 15, 20, 26 is carried out similar to the handling with the DK Sealing System.



The concrete cones

- Smooth non-porous surface
- Grey concrete colour
- Hardness strength in the centre 100 N/mm²
- Imperviousness tested on the basis of DIN 1048 Part 5 (corresponds to 50 m head of water)

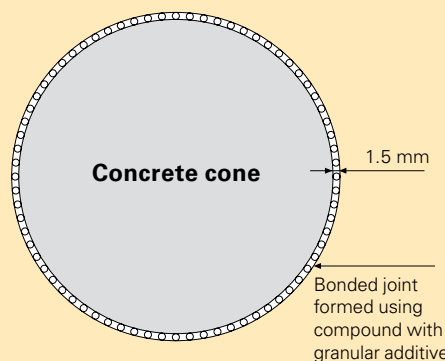

A granular material with particles of a suitable size for the gap is added to the sealing compound which centres the concrete cone in the pocket, and prevents any settling.

Sealing compound

- 2-component adhesive
 - Grey concrete colour
 - Processing time of 1 hour at 23 °C
 - Salt water resistant
 - Heat and cold resistant
 - Acid resistant to limited extent
- In accordance with the KTW recommendation concerning the levels of polymers in drinking water and the recommendation of the DVGW (German Technical and Scientific Association for Gas and Water) suitable for:
- drinking water tanks
 - containers for foodstuffs

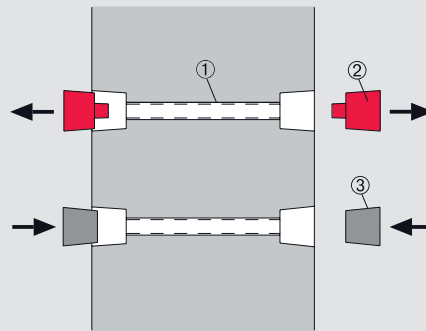

DK System

- waterproof
- gas impermeable
- fire-resistant
- soundproof

- ① Tube, rough (x1)
- ② DK Sealing Cone (2x)
- ③ DK Concrete Cone (2x)

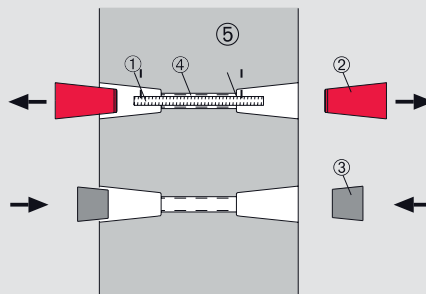

**SK System Version 1
Re-usable tie rod**

- waterproof
- gas impermeable
- fire-resistant
- soundproof

- ① Re-usable tie rod (1x)
- ② SK Anchor Cone (2x)
- ③ SK Concrete Cone (2x)
- ④ Tube, rough (x1)
- ⑤ SK Tube Sealing (2x)

Important for Tie Systems DK and SK

The spacer tubes must be exactly the same length so that the formwork can be closed cleanly. Otherwise there is the serious risk that laitance can escape, and chipped cone openings as well as bleeding on the concrete surface could occur.

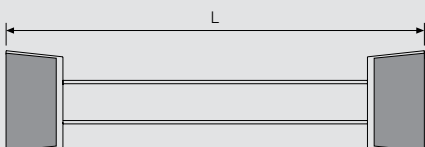

Note:

It is important that the spacer tubes of the SK and DK systems are exactly the same length.

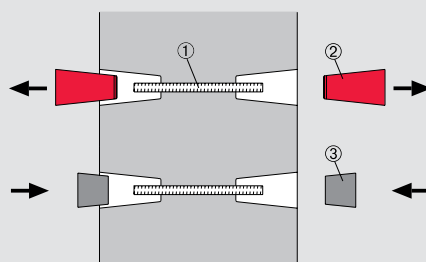

**SK System Version 2
Lost tie rod**

- waterproof
- gas impermeable
- fire-resistant
- soundproof
- suitable for strongrooms

- ① Lost tie rod (1x)
- ② SK Anchor Cone (2x)
- ③ SK Concrete Cone (2x)

Careful working procedures guarantee tight and clean tie points

Removing the DK Sealing Cone

After striking, the DK Sealing Cone is removed by means of the DK Cone Spanner UNI. The spanner is simply fitted on the cone, then slightly turned and pulled out together with the sealing cone. The cones can be re-used.

A careful working procedure when installing the spacer tubes results in tight and clean tie points.



Removing the DK Sealing Cones with the DK Cone Spanner UNI.

Installing the Concrete Cone

Important:

The surface of the cone opening must be dry and free of ice, grease and dust. The surface temperature of the sealing compound, cone and surrounding concrete must be min. + 5 °C.



Coat the cleaned pocket sparingly with the sealing compound.



Hold the concrete cone with a pair of cone pliers, and coat its tapered surface and end evenly with sealing compound.



Insert the concrete cone into the pocket, and turn slightly several times to ensure that the sealing compound is evenly spread.

Removing the SK Tie Cone

The following tools are needed to remove the SK Tie Cones:

Cone	Tool
SK Anchor Cone DW 15	Socket SW 27 – 1/2* item no. 029650
SK Anchor Cone DW 20	Socket Wrench SW 36 item no. 031480
SK Anchor Cone DW 26	Socket SW 46 – 1* item no. 029630

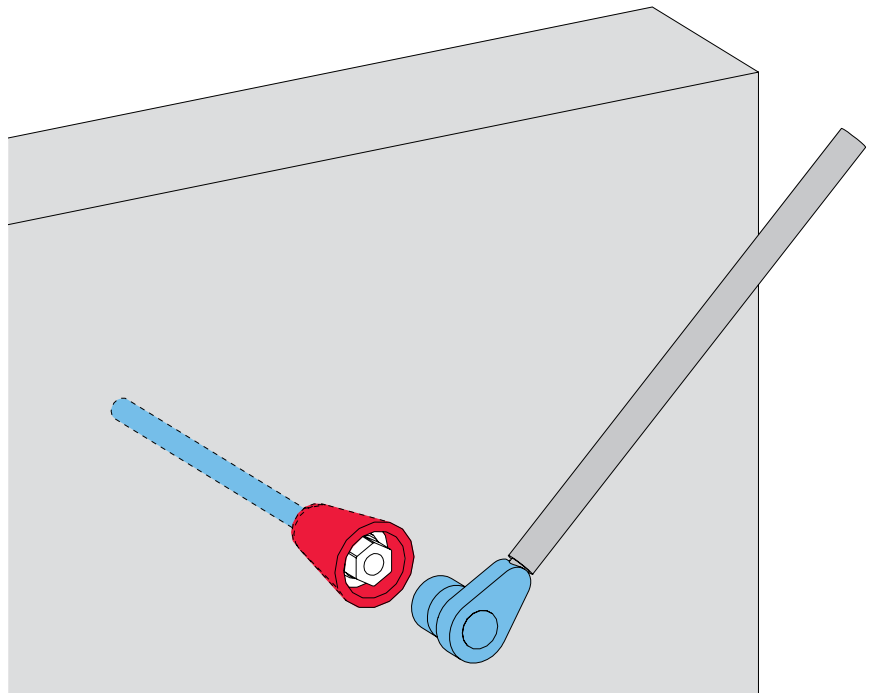

Depending on the SK Tie Cone used, the Socket SW 27, 36 or 46 is required.



Tap the concrete cone flush with the cone gauge.



Scrap the surplus compound off with a filling knife.



A clean and tight tie point with the PERI Tie System.

Special application features

Waterproof concrete

Waterproof is not the same as impermeable to water

"Impermeable to water" is used to describe materials and components into which water cannot penetrate. With "waterproof" components, more water evaporates from the side facing away than penetrates the side in contact with the water.

This means

With sealing cones which are less than 50 mm in length, there is a risk of water penetrating in the vicinity of the tie point, getting round the cone and passing along the shrinkage crack around the spacer tube. For this reason, the Sealing Cones DW 15/55 DK or SK Tie Cones DW 15 should always be used for waterproof concrete.

Gas-proof concrete

Gas-proof is not the same as gas-tight.

The PERI Tie Systems do not affect the diffusion resistance of concrete walls.

Fire protection

When complying with the measures represented in the drawing, the tie point created with the PERI Tie System DK or SK does not have any negative impact on Fire Resistance Class F 90 according to DIN 4102, Part 4.

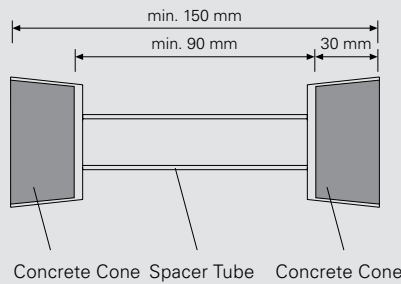

A tie point formed in this way corresponds to DIN 4102, Part 4 requirements and thus complies with Fire Resistance Class F 90 specifications. Also possible with DK Concrete Cone UNI 58/52.

If the Concrete Cone DW 15-58/30 is installed in an offset manner, the Repoxal Adhesive 031550 must be used. In that case the tie point does not comply with Fire Resistance Class F 90.

Soundproofing

Airborne sound

Regardless of the wall thickness, the use of the DK and SK systems does not have any measurable negative influences on the airborne sound insulation of the walls. This applies to all wall thicknesses, with or without insulating board fitted.

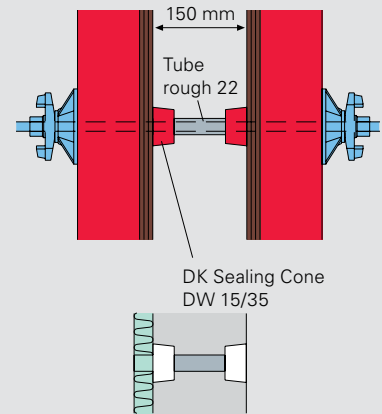

Structure-borne sound

With cavity walls, please note that the spacer tubes are not continuous in the area of the insulation. The recommendations for preventing transmission of airborne sound in cavity walls are the same as for solid walls.

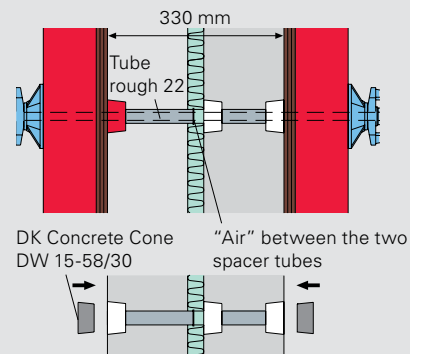

Architectural concrete

For different architectural requirements, other concrete cone variants can be used, e.g. recessed or with shadow joint (the colour of the cones may vary).



Concrete cones with shadow joint glued in place.

DK Concrete Cone DW 15-58/30, item no. 031642

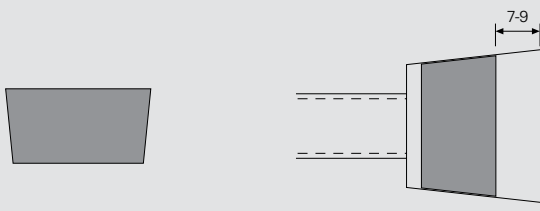

DK Concrete Cone Architectural 01 DW 15-58/52, item no. 031641

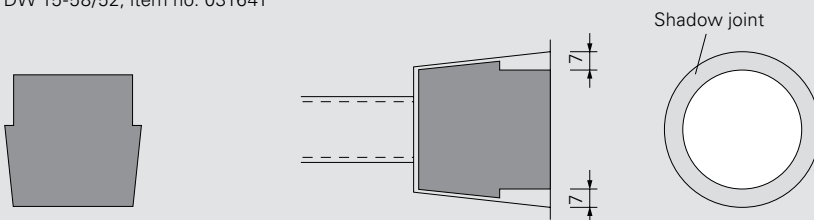

Single-sided shuttering against sheet piling

Version 1:

With reusable tie rod.

DK Cone Tie Rod, continuous Weldable Tie DW 15, item no. 031300

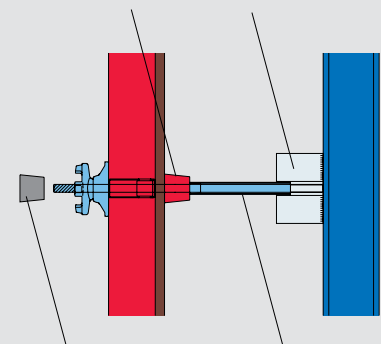

DK Concrete Cone UNI 58/52, item no. 031643 Lost tube, rough

Version 2:

With lost tie rods.

SK Cone Weldable Tie DW 15, turned item no. 031300

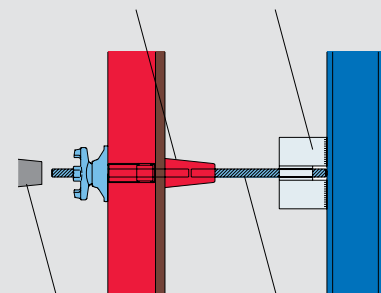

DK Concrete Cone UNI 58/52, item no. 031643 DW 15 lost

DK Sealing Cones

a

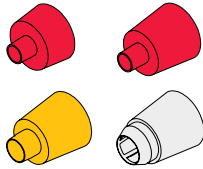

b



c

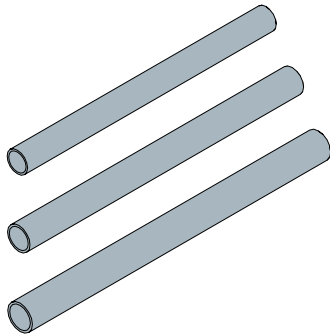

d

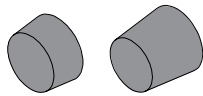

e

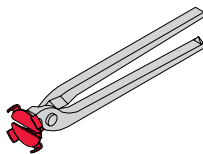

f

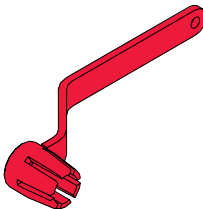

g

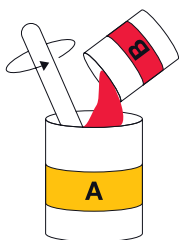

Variant DW 15/35 (red)

Used for soundproofing and F 90 fire resistance. Recommended wall thickness up to max. 60 cm.

Length of spacer tube:

= wall thickness minus 2 x 35mm

Sealing compound requirements:

approx. 44 cones/kg of sealing compound

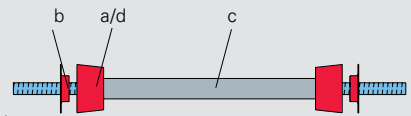

Variant DW 15/55 (red)

Used for waterproof concrete, soundproofing and F 90 fire resistance. Recommended wall thickness up to max. 60 cm.

Length of spacer tube:

= wall thickness minus 2 x 55 mm

Sealing compound requirements:

approx. 29 cones/kg of sealing compound

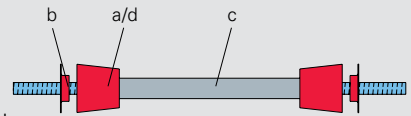

Variant DW 20/55 (yellow)

Used for waterproof concrete, soundproofing and F 90 fire resistance. Recommended wall thickness up to max. 60 cm.

Length of spacer tube:

= wall thickness minus 2 x 55 mm

Sealing compound requirements:

approx. 29 cones/kg of sealing compound

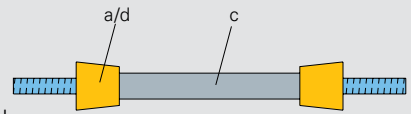

Variant DW 26/55 (white)

Used for waterproof concrete, soundproofing and F 90 fire resistance. Recommended wall thickness up to max. 60 cm.

Length of spacer tube:

= wall thickness minus 2 x 55 mm

Sealing compound requirements:

approx. 29 cones/kg of sealing compound

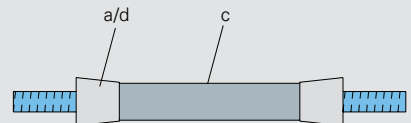

Component	Item no.	Designation	re-usable
-----------	----------	-------------	-----------

Variant DW 15/35

a	031635	DK Sealing Cone DW 15/35	X
b	031639	SK Sealing Ring UNI DW 15	X
c	065027	Tube rough 22, L = 2.0 m	
d	031642	DK Concrete Cone DW 15-58/30	
e	031644	DK Cone Pliers 58	X
f	031655	DK Cone Spanner UNI	X
g	131709	Sealing Compound-3 / Set of 6 Tins	

Variant DW 15/55

a	031636	DK Sealing Cone DW 15/55	X
b	031639	SK Sealing Ring UNI DW 15	X
c	065027	Tube rough 22, L = 2.0 m	
d	031643	DK Concrete Cone UNI 58/52	
e	031644	DK Cone Pliers 58	X
f	031655	DK Cone Spanner UNI	X
g	131709	Sealing Compound-3 / Set of 6 Tins	

Variant DW 20/55

a	031637	DK Sealing Cone DW 20/55	X
c	031626	Tube rough 28, L = 3.0 m	
d	031643	DK Concrete Cone UNI 58/52	
e	031644	DK Cone Pliers 58	X
f	031655	DK Cone Spanner UNI	X
g	131709	Sealing Compound-3 / Set of 6 Tins	

Variant DW 26/55

a	031638	DK Sealing Cone DW 26/55	X
c	031634	Tube rough 42, L = 3.0 m	
d	031643	DK Concrete Cone UNI 58/52	
e	031644	DK Cone Pliers 58	X
f	031655	DK Cone Spanner UNI	X
g	131709	Sealing Compound-3 / Set of 6 Tins	

SK Anchor Cones

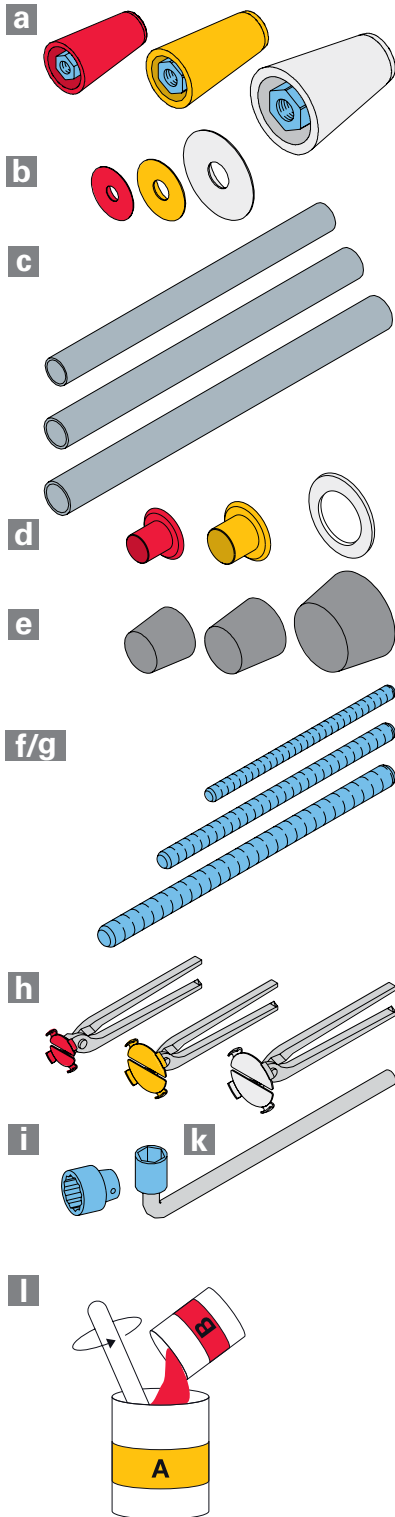

Variant DW 15 (red)
 Used for waterproof concrete, gas-proof concrete, soundproofing and F 90 fire resistance. If used without spacer tubes, still suitable for radiation-proof walls and high security areas.
 Recommended wall thickness from 24 cm.
Length of spacer tube:
 = wall thickness minus 2 x 107 mm
Length of Tie Rod DW 15:
 = wall thickness minus 2 x 55 mm
Sealing compound requirements:
 approx. 29 cones/kg of sealing compound

When using the SK Sealing Ring with SK Tie Cone, the tie rod must be shortened by 1 mm at each end.

Variant DW 20 (yellow)
 Used for waterproof concrete, gas-proof concrete, soundproofing and F 90 fire resistance. If used without spacer tubes, still suitable for radiation-proof walls and high security areas.
 Recommended wall thickness from 30 cm.
Length of spacer tube:
 = wall thickness minus 2 x 130 mm
Length of Tie Rod DW 20:
 = wall thickness minus 2 x 65 mm
Sealing compound requirements:
 approx. 22 cones/kg of sealing compound

When using the SK Sealing Ring with SK Tie Cone, the tie rod must be shortened by 1.5 mm at each end.

Variant DW 26 (white)
 Used for waterproof concrete, gas-proof concrete, soundproofing and F 90 fire resistance. If used without spacer tubes, still suitable for radiation-proof walls and high security areas.
 Recommended wall thickness from 35 cm.
Length of spacer tube:
 = wall thickness minus 2 x 142 mm
Length of Tie Rod DW 26:
 = wall thickness minus 2 x 75 mm
Sealing compound requirements:
 approx. 13 cones/kg of sealing compound

When using the SK Sealing Ring with SK Tie Cone, the tie rod must be shortened by 2 mm at each end.

Component	Item no.	Designation	re-usable
-----------	----------	-------------	-----------

Variant DW 15

a	126609	SK Anchor Cone DW 15 / 2	X
b	031639	SK Sealing Ring UNI DW 15	X
c	065027	Tube rough 22, L = 2.0 m	
d	031671	SK Tube Seal 22	
e	031643	DK Concrete Cone UNI 58/52	X
f	030030	Tie Rod DW 15, Special Length	X
g	030030	Tie Rod DW 15, Special Length	X
h	031644	DK Cone Pliers 58	X
i	029650	12-point Nut SW 27 - 1/2"	X
k	072180	Ratchet Wrench 1/2"	X
l	131709	Sealing Compound-3 / Set of 6 Tins	

Variant DW 20

a	031646	SK Anchor Cone DW 20	X
b	031648	SK Sealing Ring DW 20	X
c	031626	Tube rough 28, L = 3.0 m	
d	031672	SK Tube Seal 28	
e	031650	SK Concrete Cone DW 20-67/60	
f	030700	Tie Rod DW 20, Special Length	
g	030700	Tie Rod DW 20, Special Length	X
h	031656	SK Cone Pliers 67	X
i	031480	Socket Wrench SW 36	X
l	131709	Sealing Compound-3 / Set of 6 Tins	

Variant DW 26

a	031647	SK Anchor Cone DW 26	X
b	031649	SK Sealing Ring DW 26	X
c	031634	Tube rough 42, L = 3.0 m	
d	126013	Seal Ring 60 x 15 x 4, EPDM	
e	031651	SK Concrete Cone DW 26-100/60	
f	030340	Tie Rod DW 26, Special Length	
g	030340	Tie Rod DW 26, Special Length	X
h	031657	SK Cone Pliers 100	X
i	029630	12-point Nut SW 46 - 1"	X
k	029610	Ratchet Wrench 1"	X
l	131709	Sealing Compound-3 / Set of 6 Tins	

Tie Technology DK, SK



Sewage works in Hameln, Germany.



B311 Local Bypass Tunnel, Ertingen, Germany.



Other examples of completed projects:

- Käppala Sewage Works 2001, Sweden
- Izmit Sewage Works, Turkey
- Sewage works in Villach, Austria
- Elevated Tanks in Weilheim, Germany
- Gaggenau Groundwater Reservoir, Germany
- Seitschen Bridge, Germany
- Spremberg Housing Development, Germany



Oeresund Tunnel, from Denmark to Sweden.

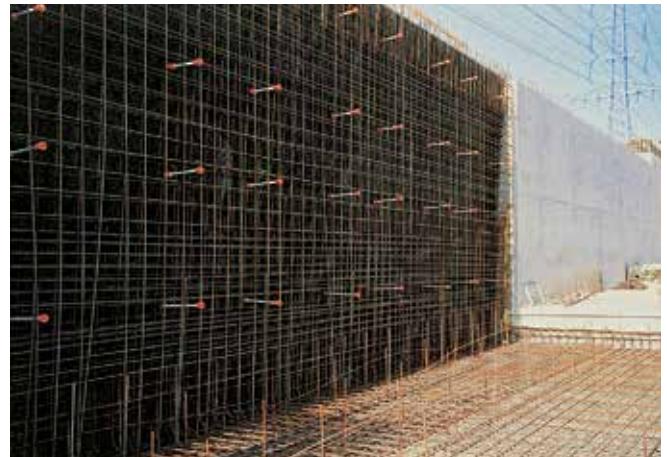

Tunnel in Häggsviksleden, Sweden.

Tie System DK, SK, KK

Item no.	Weight kg		
031635	0.043	DK Cone DW 15/35 For fire-resistant and soundproof anchor points with DW 15. Resistant to seepage. For use with Spacer Tube rough 22.	Note Delivery unit 50 pieces.
031636	0.063	DK Cone DW 15/55 For waterproof, fire-resistant and soundproof anchor points with Tie Rod DW 15. Used with Spacer Tube rough 22.	Note Delivery unit 50 pieces.
031637	0.055	DK Cone DW 20/55 For waterproof, fire-resistant and soundproof anchor points with Tie Rod DW 20. Use with Spacer Tube rough 28.	Note Delivery unit 50 pieces.
031638	0.054	DK Cone DW 26/55 For waterproof, fire-resistant and soundproof anchor points with Tie Rod DW 26. Used with Spacer Tube rough 42.	Note Delivery unit 50 pieces.
112937	0.173	Sealing Cone MX 15 For use with MAXIMO. Use with Anchor MX.	Note For use with waterproofed concrete or architectural concrete.
		Accessories Magnet Cone Spanner MX 15 / MX 18	
126696	1.220		

Item no.	Weight kg
127425	0.160

Magnet Cone MX 18 – 55
 For the use with MAXIMO.
 Use with Anchor MX.

Note
 For the use with waterproof concrete or architectural concrete.

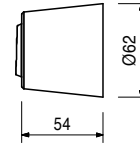
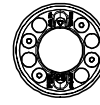
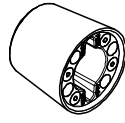

Accessories

126696	1.220
--------	-------

Magnet Cone Spanner MX 15 / MX 18

110675	0.172
--------	-------

Sealing Cone TRH 55
 For use with TRIO Housing. Use with Anchor TRH.

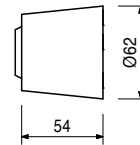
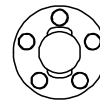
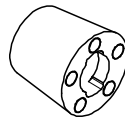

031642	0.152
--------	-------

DK Concrete Cone DW 15-58/30
 For closing anchor points with DK Sealing Cone DW 15/35, DW 15/55, DW 20/55, DW 26/55, SK Anchor Cone DW 15, Magnet Cone MX 15 - 55, Magnet Cone MX 18 - 55, Arch. Leading Cone M24.

Note
 Delivery unit 50 pieces.

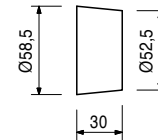
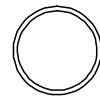
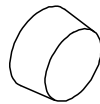

031643	0.241
--------	-------

DK Concrete Cone UNI 58/52
 For closing anchor points with DK Sealing Cone DW 15/55, DW 20/55, DW 26/55, SK Anchor Cone DW 15, Magnet Cone MX 15 - 55, Magnet Cone MX 18 - 55, Arch. Leading Cone M24.

Note
 Delivery unit 50 pieces.

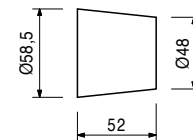
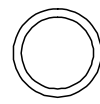
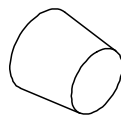

Item no.	Weight kg
132972	0.206

DK Concrete Cone Architect./02 DW 15-58/52

For closing anchor points with DK Sealing Cone DW 15/55, DW 20/55, DW 26/55, SK Anchor Cone DW 15, Magnet Cone MX 15 - 55, Magnet Cone MX 18 - 55, Arch. Leading Cone M24 with corresponding architectural requirements.

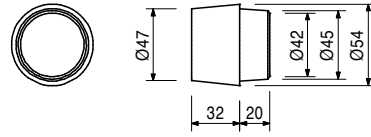
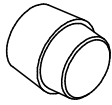

031641	0.208
--------	-------

DK Concrete Cone Architect./01 DW 15-58/52

For closing anchor points with DK Sealing Cone DW 15/55, DW 20/55, DW 26/55, SK Anchor Cone DW 15, Magnet Cone MX 15 - 55, Magnet Cone MX 18 - 55, Arch. Leading Cone M24 with corresponding architectural requirements.

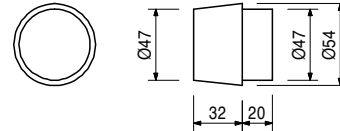
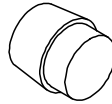

Note

Delivery unit 50 pieces.
Will placed by 132972.

126609	0.593
--------	-------

SK Anchor Cone DW 15 / 2

For waterproof, fire-resistant, soundproof and radiation-proof anchor points with Tie Rod DW 15. Suitable for vaults and strongrooms.

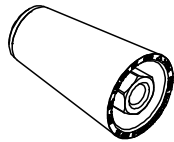

Technical Data

Permissible tension force 90 kN.
Tie rod length = wall thickness - 2 x 55 mm

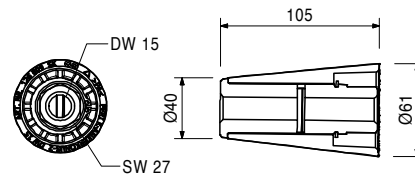

031646	1.030
--------	-------

SK Anchor Cone DW 20

For waterproof, fire-resistant, soundproof and radiation-proof anchor points with Tie Rod DW 20. Suitable for vaults and strongrooms.

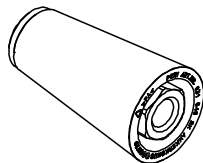

Technical Data

Permissible tension force 150 kN.
Tie rod length = wall thickness - 2 x 65 mm

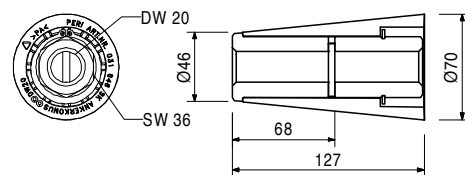

Item no.	Weight kg
031647	1.920

SK Anchor Cone DW 26

For waterproof, fire-resistant, soundproof and radiation-proof anchor points with Tie Rod DW 26. Suitable for vaults and strongrooms.

Technical Data

Permissible tension force 250 kN.
Tie rod length = wall thickness - 2 x 75 mm

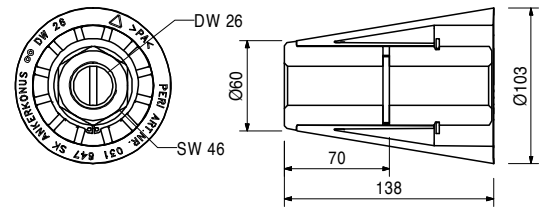
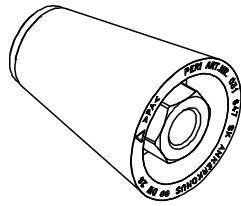

031639	0.006
--------	-------

SK Sealing Washer UNI DW 15

For sealing DK Sealing Cones DW 15 and SK Anchor Cones DW 15 on the formwork side.

Note

Delivery unit 50 pieces.
When using the SK Sealing Cover with SK Anchor Cone, the tie rod must be shortened by 1 mm on each side.

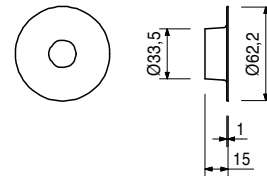

031648	0.008
--------	-------

SK Sealing Washer DW 20

For sealing SK Anchor Cones DW 20 on the formwork side.

Note

Delivery unit 50 pieces.
When using the SK Sealing Cover with SK Anchor Cone, the tie rod must be shortened by 1.5 mm on each side.

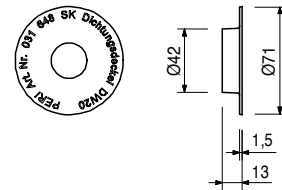

031649	0.014
--------	-------

SK Sealing Washer DW 26

For sealing SK Anchor Cones DW 26 on the formwork side.

Note

Delivery unit 50 pieces.
When using the SK Sealing Cover with SK Anchor Cone, the tie rod must be shortened by 2 mm on each side.

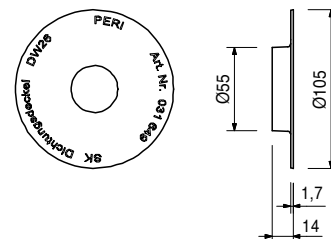

Tie System DK, SK, KK

Item no.	Weight kg		
031671	0.002	SK Tube Seal 22 For spacer tube rough.	Note Delivery unit 250 pieces.
031672	0.003	SK Tube Seal 28 For spacer tube rough.	Note Delivery unit 250 pieces.
126013	0.002	Sealing Ring 60 x 15 x 4, EPDM For spacer tube rough.	Note Delivery unit 100 pieces.
031643	0.241	DK Concrete Cone UNI 58/52 For closing anchor points with DK Sealing Cone DW 15/55, DW 20/55, DW 26/55, SK Anchor Cone DW 15, Magnet Cone MX 15 - 55, Magnet Cone MX 18 - 55, Arch. Leading Cone M24.	Note Delivery unit 50 pieces.
031650	0.364	SK Concrete Cone DW 20-67/60 For closing anchor points with SK Anchor Cone DW 20.	Note Delivery unit 50 pieces.
131709	9.980	Accessories Sealing Compound-3, 6 cans-set	

Item no. Weight kg

031651 0.801

SK Concrete Cone DW 26-100/60
For closing anchor points with SK Anchor Cone DW 26.

Note
Delivery unit 50 pieces.

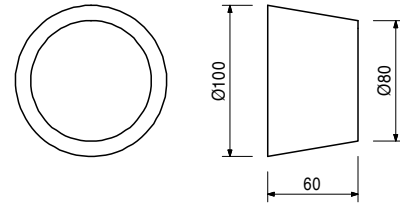
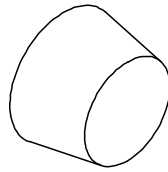

Accessories

131709 9.980

Sealing Compound-3, 6 cans-set

104643 0.260

SK Lead Cone DW 15
For closing tie holes with SK Anchor Cone DW 15 for radiation-proof areas.

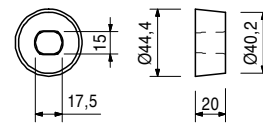

031652 0.247

KK Concrete Cone M24-67/52
For closing anchor points with Climbing Cone-2, M24/DW 15 and Screw-On Cone-2 M24/DW 20.

Note
Delivery unit 50 pieces.

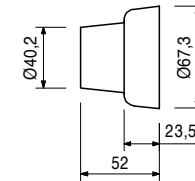
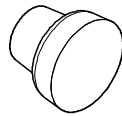

Accessories

131709 9.980

Sealing Compound-3, 6 cans-set

031653 0.364

KK Concrete Cone M30-80/52
For closing anchor points with Climbing Cone-2 M30/DW 20 or Screw-On Cone M30/DW 26.

Note
Delivery unit 50 pieces.

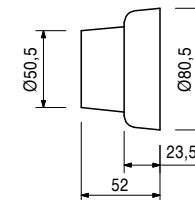
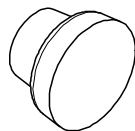

Accessories

131709 9.980

Sealing Compound-3, 6 cans-set

Tie System DK, SK, KK



Item no.	Weight kg
031654	0.512

KK Concrete Cone M36-90/52
For closing anchor points with Climbing Cone-2 M36/DW 26.

Note
Delivery unit 50 pieces.

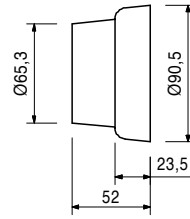
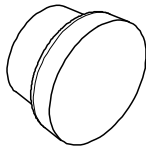

Accessories

131709	9.980
--------	-------

Sealing Compound-3, 6 cans-set

131709	9.980
--------	-------

Sealing Compound-3, 6 cans-set
For bonding PERI Concrete Cones.

Note
See Safety Data sheet!
Consisting of:
6 x Component A, 6 x Component B

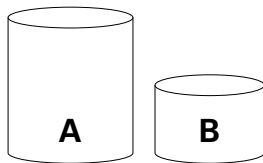

131710	0.890
--------	-------

Sealing Adhesive-3 can CO-A

131711	0.670
--------	-------

Sealing Adhesive-3 can CO-B

126696	1.220
--------	-------

Magnet Cone Spanner MX 15 / MX 18
For dismantling of Magnet Cone MX 15 and MX 18.

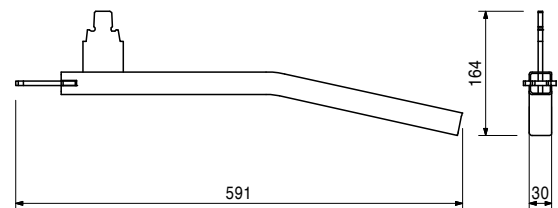
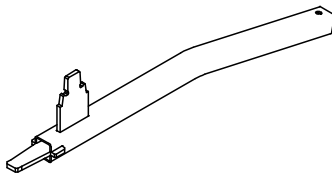

Item no.	Weight kg
031655	0.940

DK Cone Remover UNI
For removing DK Sealing Cones.

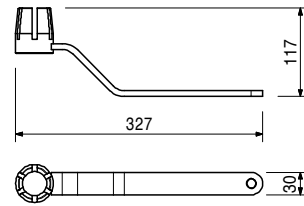
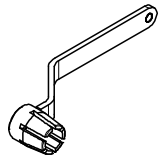

110634	0.383
--------	-------

Cone Spanner TRH
For removing Sealing Cone TRH 55.

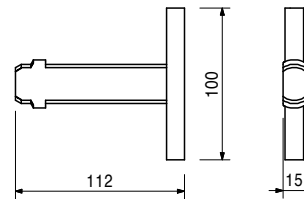
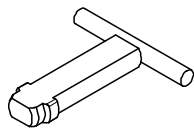

031644	0.588
031656	0.600
031657	0.660

DK, SK Tong for Concrete Cones
DK Tong for Concrete Cone 58
SK Tong for Concrete Cone 67
SK Tong for Concrete Cone 100
For holding DK, SK or KK Concrete Cones with corresponding diameter during installation.

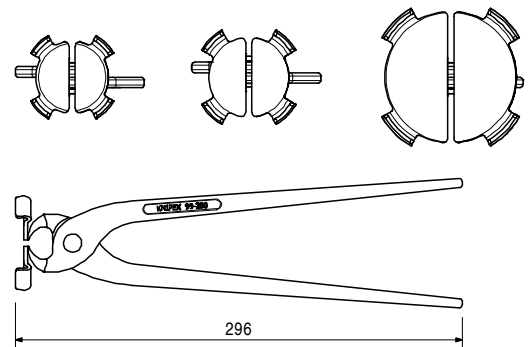
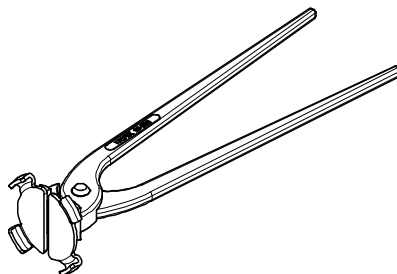

101995	1.020
--------	-------

Concrete Cone Gauge
Installation of concrete cones flush with the surface.

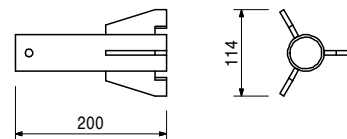
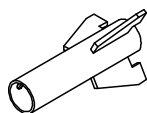

Tie System DK, SK, KK

Item no. Weight kg

031480

2.460

Socket Wrench SW 36, chrome-plated

For various purposes.

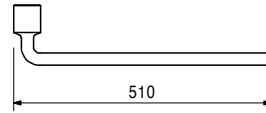
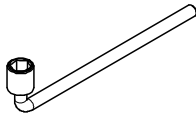

072180

0.560

Ratchet Wrench 1/2"

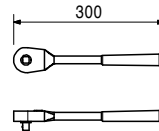
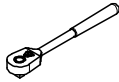

029610

5.300

Ratchet Wrench 1"

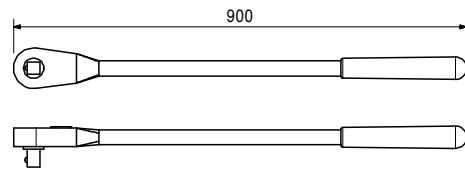
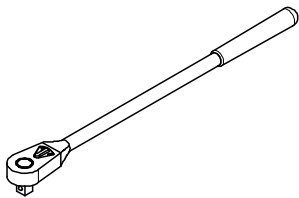

029630

0.580

Socket SW 46-1"

Fits to Hex. Bolts M30.

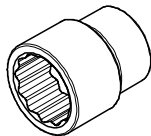

029650

0.160

Socket SW 27-1/2"



Item no.	Weight kg
115499	0.878

Leading Cone Screw DW 26
 For recovering the Arch. Leading Cone M24/DW 26.

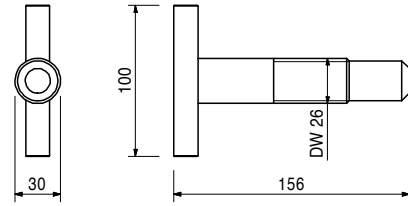
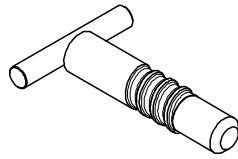

116385	0.189
--------	-------

Arch. Leading Cone M24/DW 26
 Leading cone for single- or double-sided architectural concrete anchorings CB. Creates a recess for Arch. Mounting Cone M24 and Concrete Cone DK 58/52.

Note
 Plastic version.

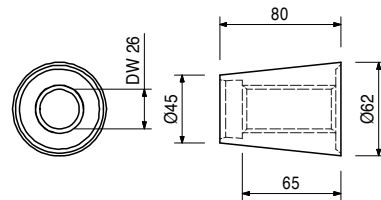
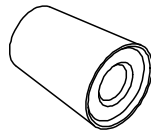

Accessories

115499	0.878
--------	-------

Leading Cone Screw DW 26

125512	0.966
--------	-------

Arch. Leading Cone M24/DW 26 Steel
 Leading cone for single- or double-sided architectural anchorings CB. Creates a recess for Arch. Mounting Cone M24 and concrete cone DK 58/52. Can also be used as shear cone for anchoring FB or KG Brackets.

Note
 Steel version.
 Separate design information on request.

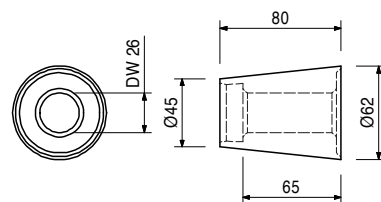
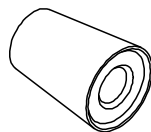

Accessories

115499	0.878
--------	-------

Leading Cone Screw DW 26

Item no.	Weight kg
031300	1.350

Weld on Anchor DW 15
For anchoring single-sided formwork.

Technical Data
Permissible tension force 90 kN.

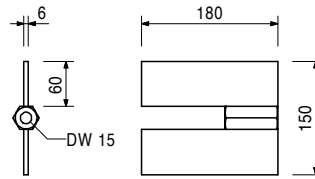
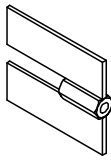

065027	0.359
--------	-------

Spacer Tube rough DR 22, l = 2.00 m
Plastic spacer tube for DW 15, B 15.

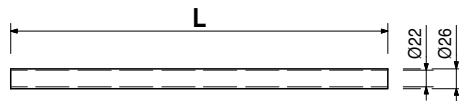
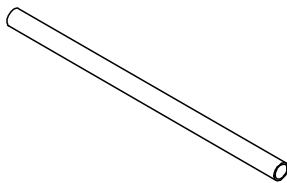

031626	0.886
--------	-------

Spacer Tube rough DR 28, l = 3.00 m
Plastic Spacer Tube for DW 20, B 20.

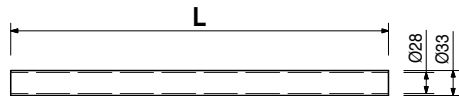
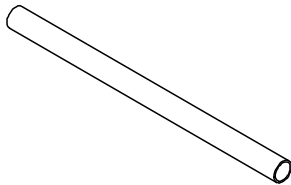

031634	1.250
--------	-------

Spacer Tube rough DR 42, l = 3.00 m
Plastic spacer tube for DW 20, 26.

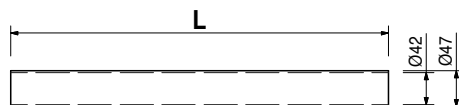
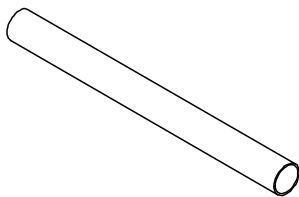

030030	1.440
030050	0.000

Tie Rod DW 15
Tie Rod DW 15, spec. length
Cutting Cost Tie Rod DW 15, B 15

Note
Non-weldable! Take official Approval into consideration!

Technical Data
Permissible tension force 90 kN.

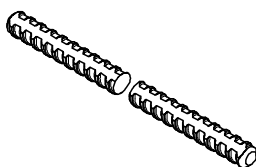

Tie System DK, SK, KK

Item no.	Weight kg
030700	2.560
030800	0.000

Tie Rod DW 20
Tie Rod DW 20, spec. length
Cutting Cost Tie Rod DW 20/B 20

Note
Non-weldable! Take official Approval into consideration!
Technical Data
Permissible tension force 150 kN.

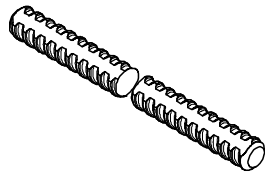

030340	4.480
030500	0.000

Tie Rod DW 26
Tie Rod DW 26, spec. length
Cutting Cost Tie Rod DW 26

Note
Non-weldable! Take official approval into consideration!
Technical Data
Permissible tension force 250 kN.

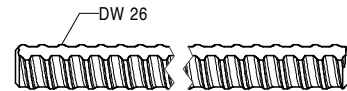
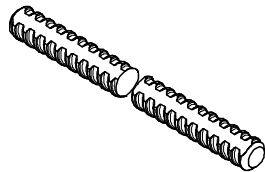

PERI International

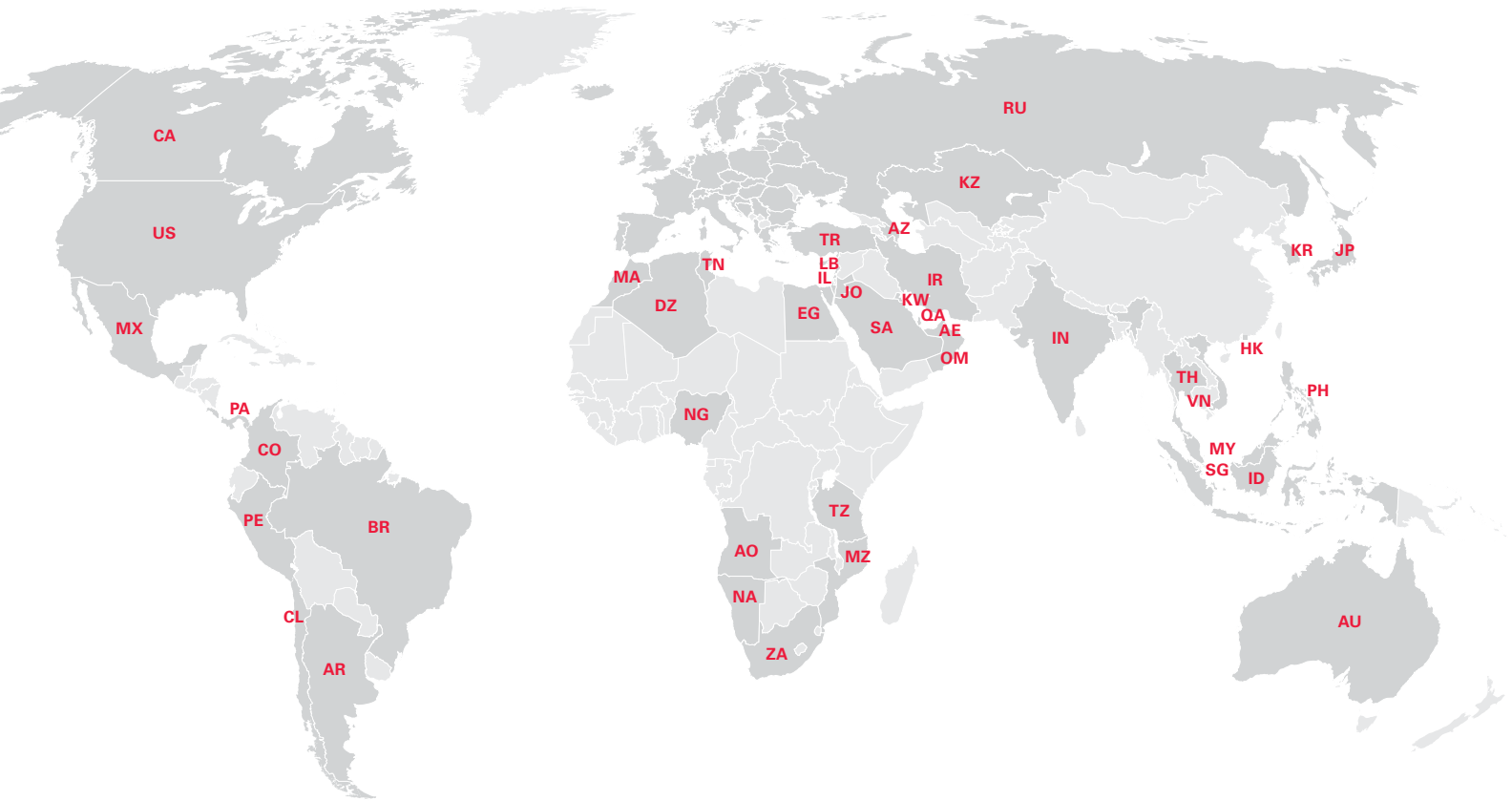

North America

- CA** Canada
PERI Formwork Systems, Inc.
www.peri.ca
- MX** Mexico
PERI Cimbras y Andamios, S.A. de C.V.
www.peri.com.mx
- PA** Panama
PERI Panama Inc.
www.peri.com.pa
- US** USA
PERI Formwork Systems, Inc.
www.peri-usa.com

South America

- AR** Argentina
PERI S.A.
www.peri.com.ar
- BR** Brazil
PERI Formas e Escoramentos Ltda.
www.peribrasil.com.br
- CL** Chile
PERI Chile Ltda.
www.peri.cl
- CO** Colombia
PERI S.A.S.
www.peri.com.co
- PE** Peru
PERI Peruana S.A.C.
www.peri.com.pe

Africa

- AO** Angola
Pericofragens, Lda.
www.peri.pt
- DZ** Algeria
S.A.R.L. PERI
www.peri.dz
- EG** Egypt
Egypt Branch Office
www.peri.com.eg
- MA** Morocco
PERI S.A.
www.peri.ma
- MZ** Mozambique
PERI (Pty.) Ltd.
www.peri.co.mz
- NA** Namibia
PERI (Pty.) Ltd.
www.peri.na
- NG** Nigeria
PERI Nigeria Ltd.
www.peri.ng
- TN** Tunisia
PERI S.A.U.
www.peri.es
- TZ** Tanzania
PERI Formwork and Scaffolding Ltd
www.peri.co.tz
- ZA** South Africa
PERI Formwork Scaffolding (Pty) Ltd
www.peri.co.za

Asia

- AE** United Arab Emirates
PERI (L.L.C.)
www.peri.ae
- AZ** Azerbaijan
PERI Representative Office
www.peri.com.tr
- HK** Hong Kong
PERI (Hong Kong) Limited
www.perihk.com
- ID** Indonesia
PT Beton Perkasa Wijaksana
www.betonperkasa.com
- IL** Israel
PERI F.E. Ltd.
www.peri.co.il
- IN** India
PERI (India) Pvt Ltd
www.peri.in
- IR** Iran
PERI Pars. Ltd.
www.peri.ir
- JO** Jordan
PERI GmbH – Jordan
www.peri.com
- JP** Japan
PERI Japan K.K.
www.peri.co.jp
- KR** Korea
PERI (Korea) Ltd.
www.perikorea.com
- KW** Kuwait
PERI Kuwait W.L.L.
www.peri.com.kw
- KZ** Kazakhstan
TOO PERI Kazakhstan
www.peri.kz
- LB** Lebanon
PERI Lebanon Sarl
lebanon@peri.de
- MY** Malaysia
PERI Formwork Malaysia Sdn. Bhd.
www.perimalaysia.com
- OM** Oman
PERI (L.L.C.)
www.peri.ae
- PH** Philippines
PERI-Asia Philippines, INC.
www.peri.com.ph
- QA** Qatar
PERI Qatar LLC
www.peri.qa
- SA** Saudi Arabia
PERI Saudi Arabia Ltd.
www.peri.com.sa
- SG** Singapore
PERI Asia Pte Ltd
www.periasia.com
- TH** Thailand
Peri (Thailand) Co., Ltd.
www.peri.co.th
- TR** Turkey
PERI Kalıp ve İskeleleri
www.peri.com.tr
- VN** Vietnam
PERI ASIA PTE LTD
www.peri.com.vn



PERI

PERI GmbH Formwork Scaffolding Engineering

Rudolf-Diesel-Strasse 19
89264 Weissenhorn
Germany
Tel. +49 (0)7309.950-0
Fax +49 (0)7309.951-0
info@peri.com
www.peri.com

Oceania

AU Australia
PERI Australia Pty. Ltd.
www.periaus.com.au

DK Denmark
PERI Danmark A/S
www.peri.dk

IT Italy
PERI S.r.l.
www.peri.it

SE Sweden
PERI Sverige AB
www.peri.se

Europe

EE Estonia
PERI AS
www.peri.ee

LT Lithuania
PERI UAB
www.peri.lt

SI Slovenia
PERI oplate i skele d.o.o.
www.peri.com.hr

AL Albania
PERI Kalıp ve İskeleleri
www.peri.com.tr

ES Spain
PERI S.A.U.
www.peri.es

LU Luxembourg
N.V. PERI S.A.
www.peri.lu

SK Slovakia
PERI spol. s. r.o.
www.peri.sk

AT Austria
PERI Ges.mbh
www.peri.at

FI Finland
PERI Suomi Ltd. Oy
www.perisuomi.fi

LV Latvia
PERI SIA
www.peri-latvija.lv

UA Ukraine
TOW PERI
www.peri.ua

BA Bosnia and Herzegovina
PERI oplate i skele d.o.o.
www.peri.com.hr

FR France
PERI S.A.S.
www.peri.fr

NL Netherlands
PERI b.v.
www.peri.nl

BE Belgium
PERI N.V.
www.peri.be

GB United Kingdom
PERI Ltd.
www.peri.ltd.uk

NO Norway
PERI Norge AS
www.peri.no

BG Bulgaria
PERI Bulgaria EOOD
www.peri.bg

GR Greece
PERI Hellas Ltd.
www.perihellas.gr

PL Poland
PERI Polska Sp. z o.o.
www.peri.com.pl

BY Belorussia
IOOO PERI
www.peri.by

HR Croatia
PERI oplate i skele d.o.o.
www.peri.com.hr

PT Portugal
Pericofragens Lda.
www.peri.pt

CH Switzerland
PERI AG
www.peri.ch

HU Hungary
PERI Kft.
www.peri.hu

RO Romania
PERI România SRL
www.peri.ro

CZ Czech Republic
PERI spol. s r.o.
www.peri.cz

IR Ireland
Siteserv Access & Formwork
www.siteservaccess.ie

RS Serbia
PERI oplate d.o.o.
www.peri.rs

DE Germany
PERI GmbH
www.peri.de

IS Iceland
Armar ehf.
www.armor.is

RU Russia
OOO PERI
www.peri.ru

**The optimal System
for every Project and
every Requirement**



Wall Formwork



Column Formwork



Slab Formwork



Climbing Systems



Bridge Formwork



Tunnel Formwork



Shoring Systems



Construction Scaffold



Facade Scaffold



Industrial Scaffold



Access



Protection Scaffold



Safety Systems



**System-Independent
Accessories**



Services



PERI GmbH
Formwork Scaffolding Engineering
 Rudolf-Diesel-Strasse 19
 89264 Weissenhorn
 Germany
 Tel. +49 (0)7309.950-0
 Fax +49 (0)7309.951-0
 info@peri.com
 www.peri.com

